



Hayatınıza **Sanat Katıyoruz**

We Add Art to Your Life

UPVC Sistemleri / *UPVC Systems*



- Classic Plus**
- 2. Kesit ve Teknik Detaylar**
Section and Technical Details
 - 3. Ana Profil**
Main Profile
 - 4. Yardımcı Profil**
Axuliary Profile
 - 5/7. Birleşim Detayları**
Connection Details

- Classic 70**
- 8. Kesit ve Teknik Detaylar**
Section and Technical Details
 - 9. Ana Profil**
Main Profile
 - 10. Yardımcı Profil**
Axuliary Profile
 - 11/13. Birleşim Detayları**
Connection Details

- Classic 60**
- 14. Kesit ve Teknik Detaylar**
Section and Technical Details
 - 15. Ana Profil**
Main Profile
 - 16. Yardımcı Profil**
Axuliary Profile
 - 17/19. Birleşim Detayları**
Connection Details

- Classical Sliding**
- 20. Kesit ve Teknik Detaylar**
Section and Technical Details
 - 21. Ana Profil**
Main Profile
 - 22. Yardımcı Profil**
Axuliary Profile
 - 23/26. Birleşim Detayları**
Connection Details



Teknik Detaylar / Technical Details

Profil Geniřliđi	Profile Width	70 mm	70 mm
Odacık Sayısı	Number of Chambers	5 Odacıklı Sistem	5 Chambers System
Conta Tipi / Rengi	Gasket Model /Color	TPE Siyah/Gri	TPE Black / Grey
Cam Kalınlıkları	Glass Thickness	4, 20, 24, 30 mm	4, 20, 24, 30 mm
Isı İletim Katsayısı UF	UF Value	1,31 W/m ² K	1,31 W/m ² K

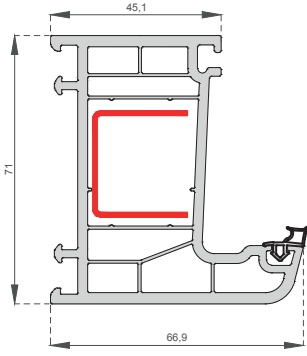

Kasa Profili
Frame Profile
C-7101

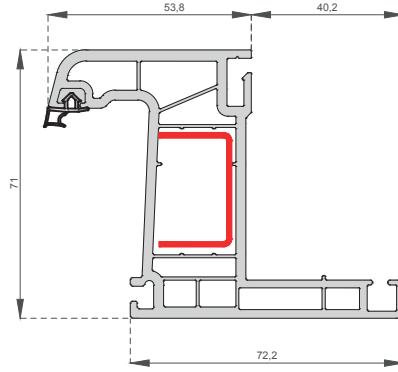

Pervazlı Kasa Profili
Frame Profile With Architrave
C-7102

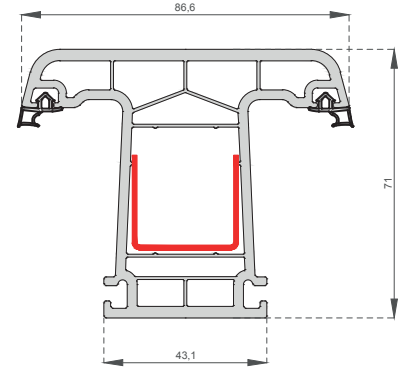

Orta Kayıt Profili
Mullion Profile
C-7103

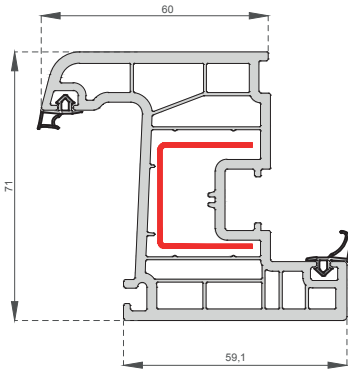

Kanat Profili
Sash Profile
C-7104

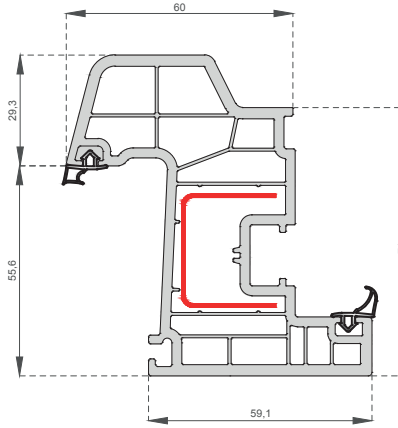

Damlıklıklı Kanat Profili
Window Sash With Drip Profile
C-7105

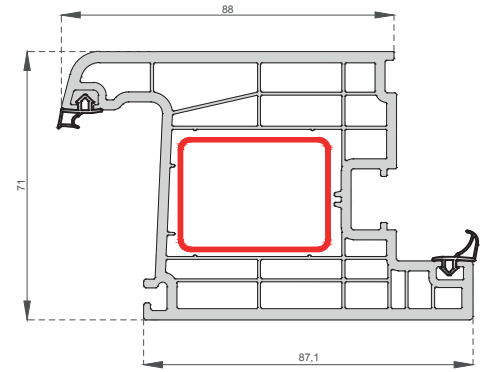

Kapı Profili
Door Profile
C-7106

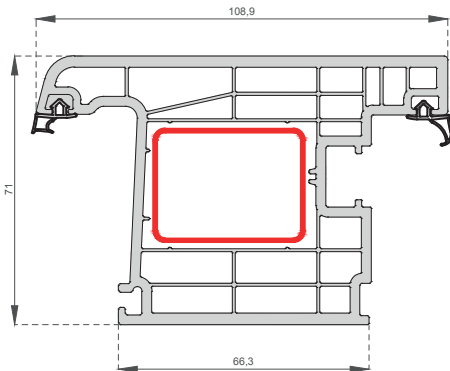

Dışa Açılır Kapı Profili
Outward Opening Door
C-7107

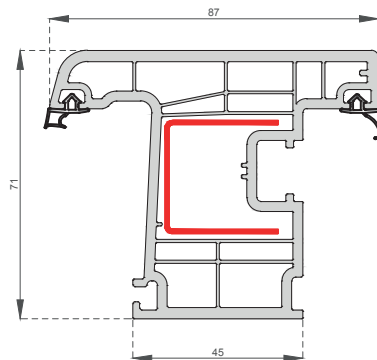

Dışa Açılır Kanat Profili
Outward Opening Sash Profile
C-7108

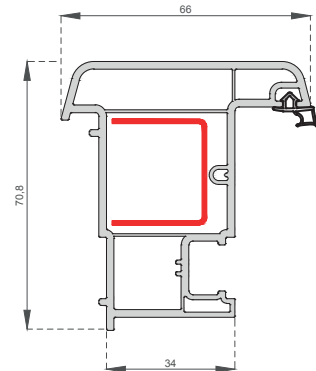

Hareketli Orta Kayıt Profili
Movable Mullion Profile
A-1008

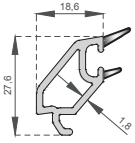

30mm.Cama Göre Çıta
Glazing With 30mm.Gap
A-1001

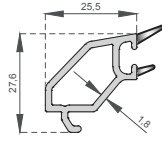

24mm.Cama Göre Çıta
Glazing With 24mm.Gap
A-1002

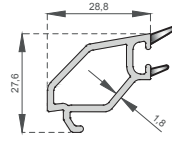

20mm.Cama Göre Çıta
Glazing With 20mm.Gap
A-1003

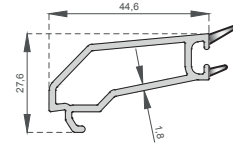

6mm.Cama Göre Çıta
Glazing With 6mm.Gap
A-1004

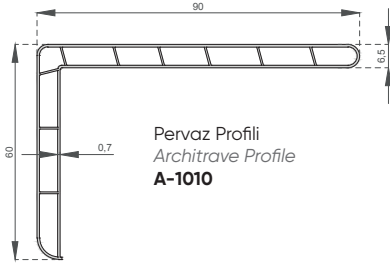

Pervaz Profili
Architrave Profile
A-1010

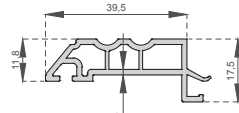

Motifli Pervaz Profili
Patterned Architrave Profile
A-1011

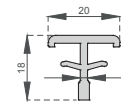

İnce Bağ Profili
Thin Bond Profile
A-1012

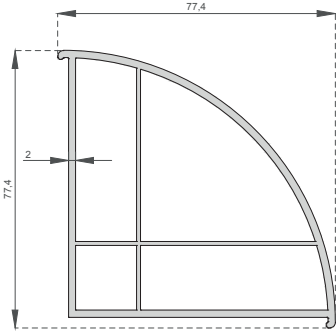

90 Derece Köşe Dönüş Adaptörü
90 Degree Corner Turn Adapter
A-1013

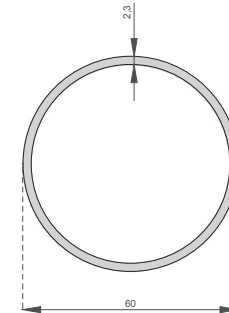

60'lık Boru Profili
60' Pipe Profile
A-1014

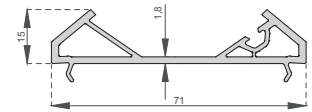

70'lik Köşe Dönüş Adaptörü
Corner Turn Adapter
A-1015

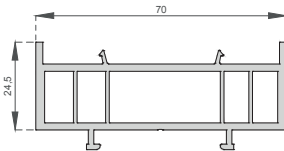

70'lik Kasa Yükseltme Profili
Frame Lifting Profile
A-1017

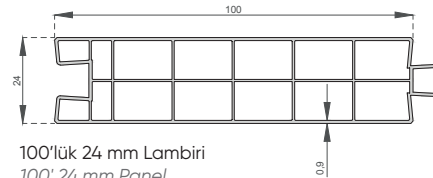

100'lük 24 mm Lambiri
100' 24 mm Panel
A-1019

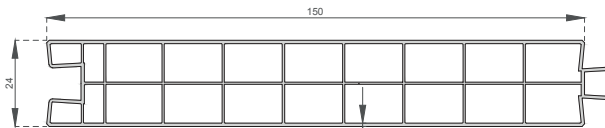

150'lük 24 mm Lambiri
150' 24 mm Panel
A-1020



Kasa Sol Conta
Frame Left Gasket
PSC 36



Kasa Sağ Conta
Frame Right Gasket
PSC 37



Kanat Üst Conta
Sash Upper Gasket
PSC 38

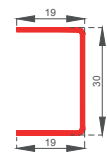

Pervazlı Kasa
Destek Sacı
Reinforcement
Steel For Frame
With Architrave

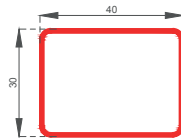

Kapı Destek Sacı
Reinforcement Steel
For Door

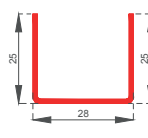

Kasa Destek Sacı
Orta Kayıt Destek Sacı
Kanat Destek Sacı
Hareketli Orta Kayıt Destek Sacı
Frame/Mullion/Sash/
Movable Mullion
Reinforcement Steel

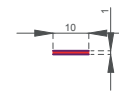

Pervazlı Kasa & Kanat
Menteşe Destek Sacı
Hinge Support Reinforcement
for Sash and Frame with
Architrave
A-1022

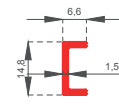

Menteşe Destek Sacı
Hinge Support Reinforcement
for Case
A-1021

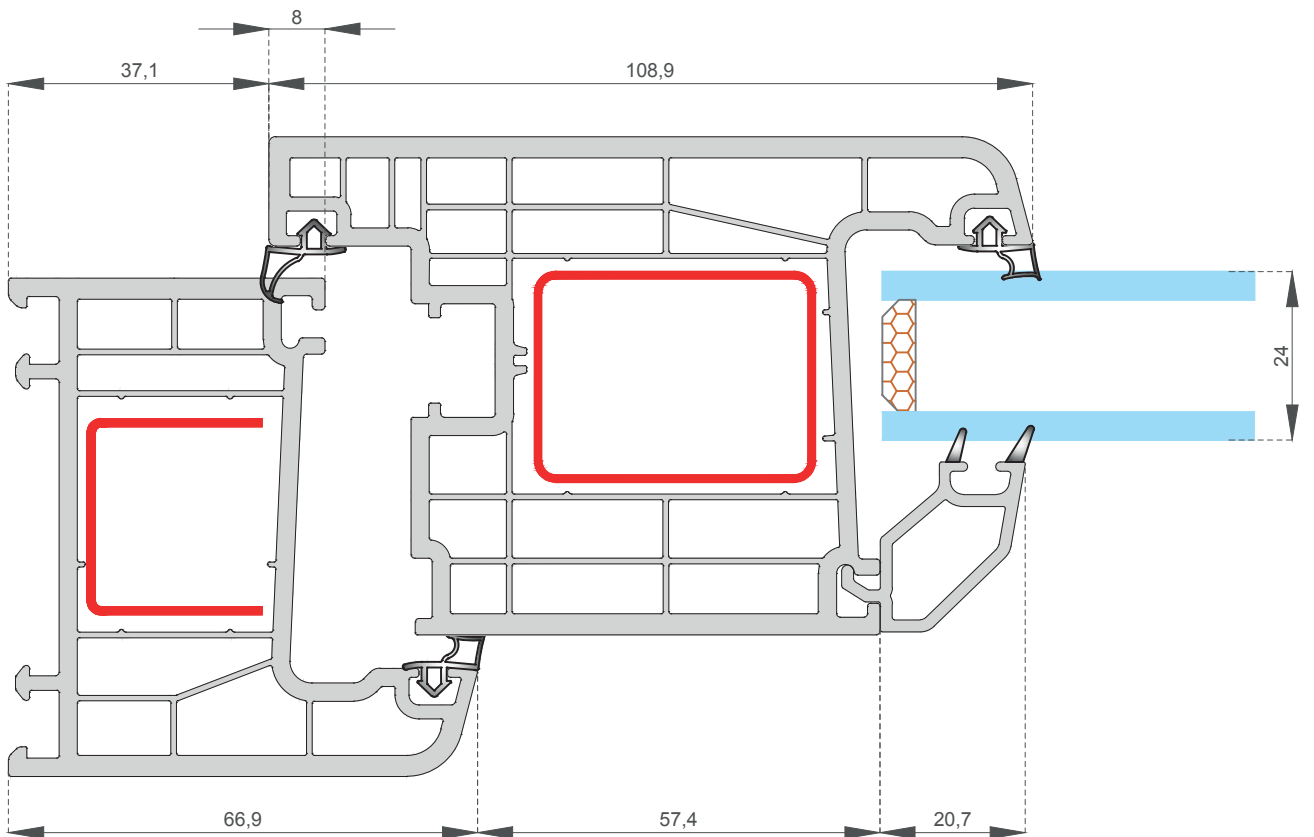
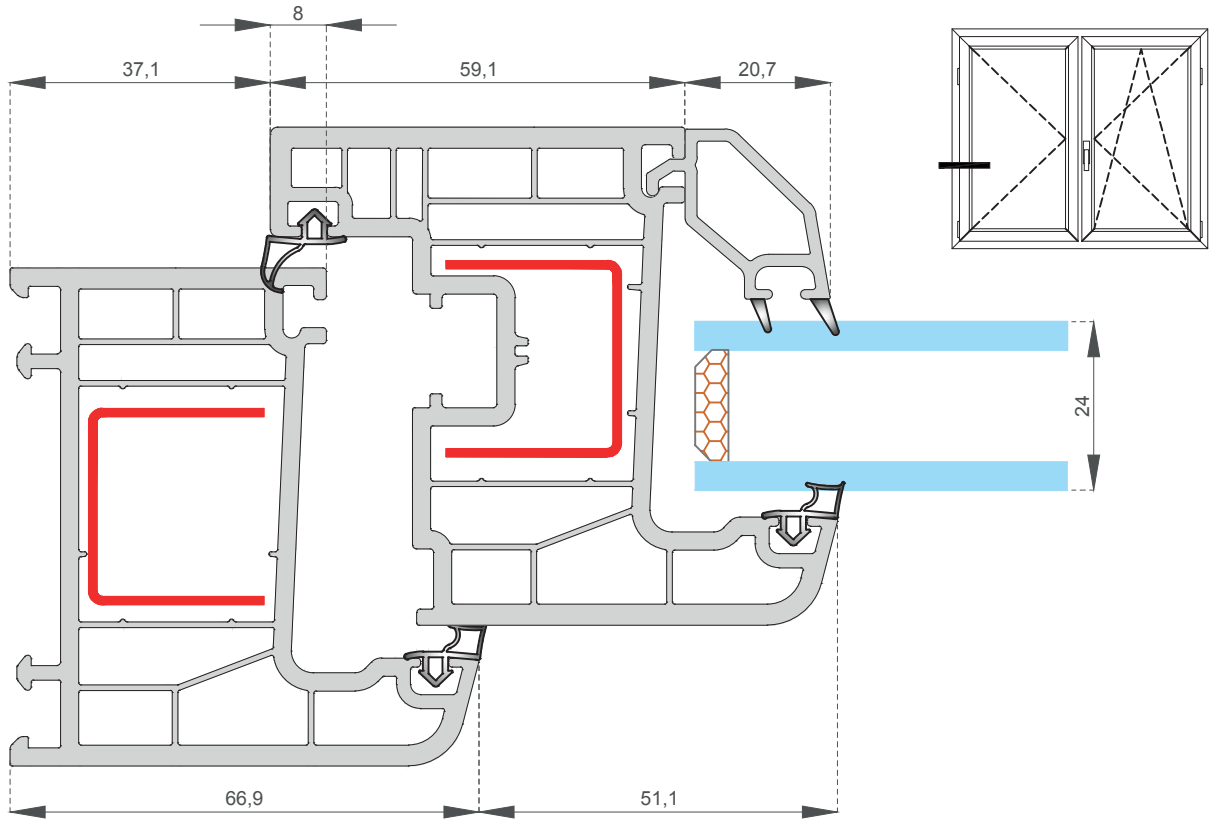

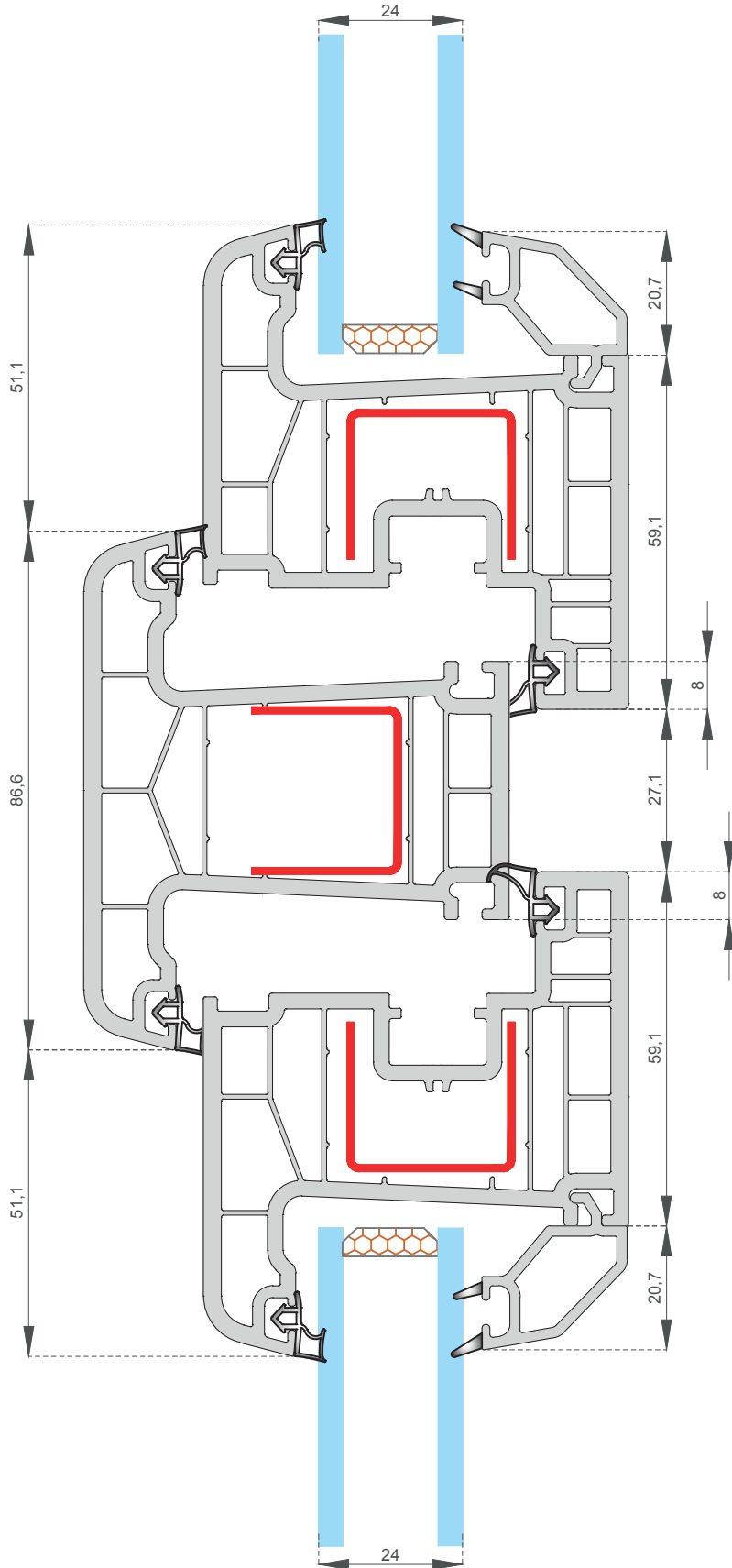

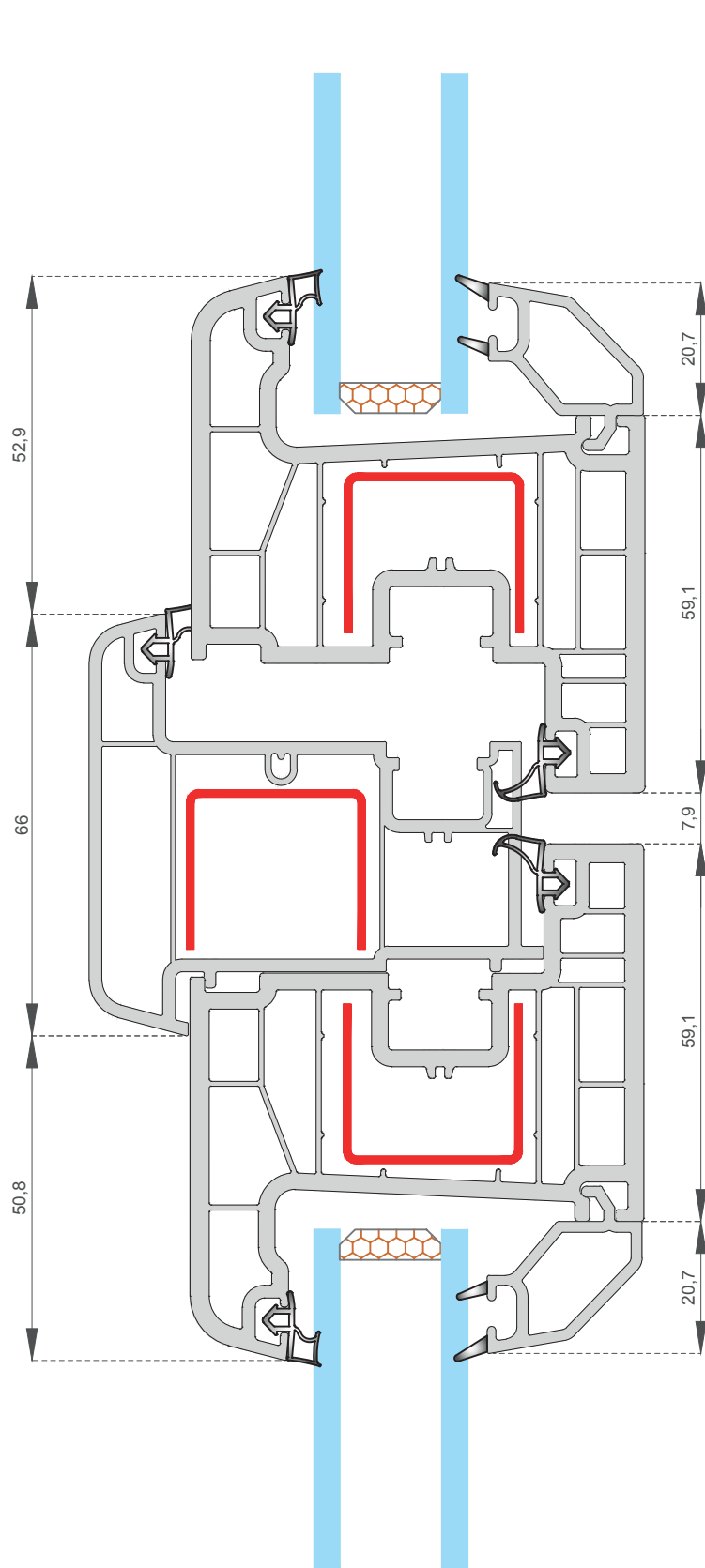



Teknik Detaylar / Technical Details

Profil Geniřliđi	Profile Width	70 mm	70 mm
Odacık Sayısı	Number of Chambers	5 Odacıklı Sistem	5 Chambers System
Conta Tipi / Rengi	Gasket Model /Color	TPE Siyah/Gri	TPE Black / Grey
Cam Kalınlıkları	Glass Thickness	4, 20, 24, 30 mm	4, 20, 24, 30 mm
Isı İletim Katsayısı UF	UF Value	1,31 W/m ² K	1,31 W/m ² K

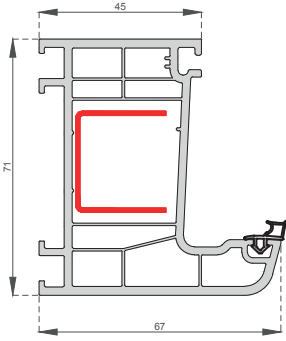

Kasa Profili
Frame Profile
C-7001

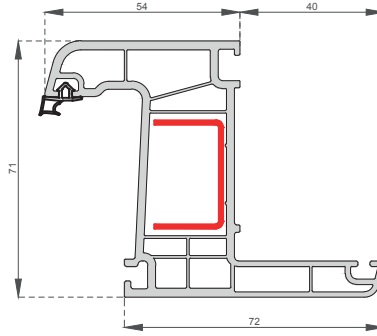

Pervazlı Kasa Profili
Frame Profile With Architrave
C-7002

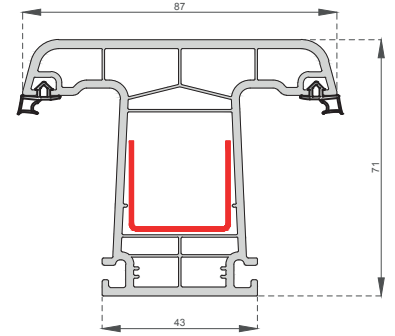

Orta Kayıt Profili
Mullion Profile
C-7003

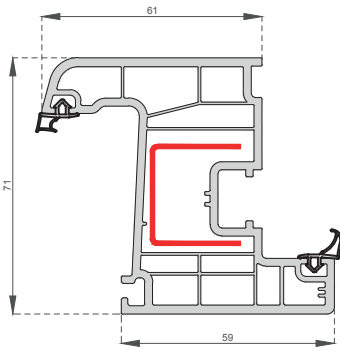

Kanat Profili
Sash Profile
C-7004

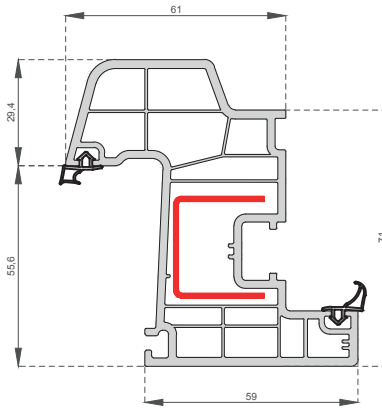

Damlıklı Kanat Profili
Window Sash With Drip Profile
C-7005

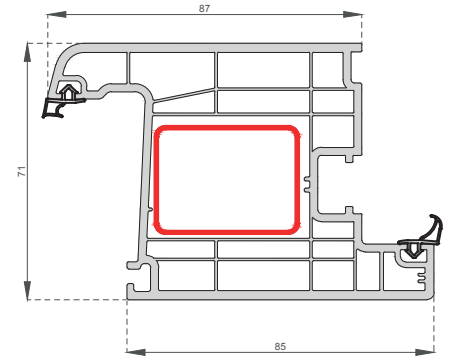

Kapı Profili
Door Profile
C-7006

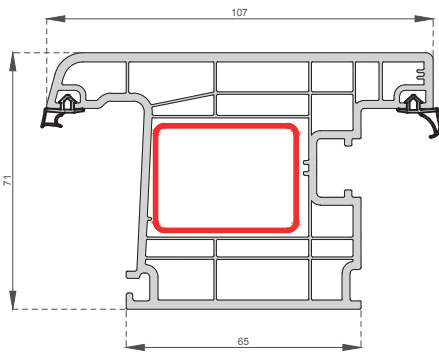

Dışa Açılır Kapı Profili
Outward Opening Door
C-7007

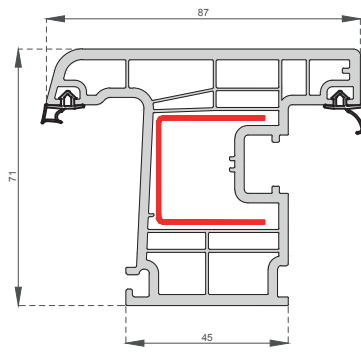

Dışa Açılır Kanat Profili
Outward Opening Sash Profile
C-7008

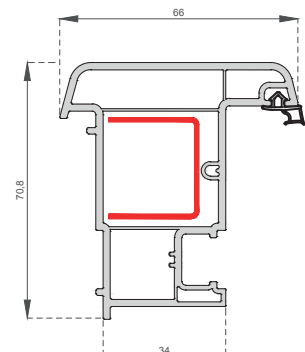

Hareketli Orta Kayıt Profili
Movable Mullion Profile
A-1008

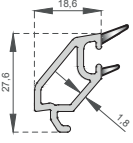

30mm.Cama Göre Çıta
Glazing With 30mm.Gap
A-1001

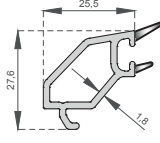

24mm.Cama Göre Çıta
Glazing With 24mm.Gap
A-1002

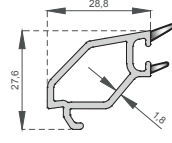

20mm.Cama Göre Çıta
Glazing With 20mm.Gap
A-1003

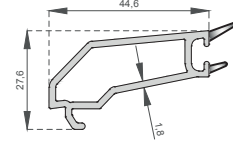

6mm.Cama Göre Çıta
Glazing With 6mm.Gap
A-1004

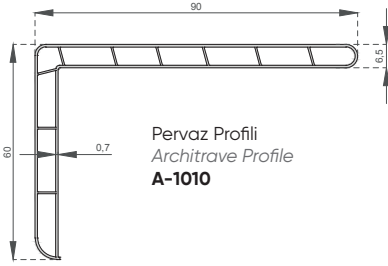

Pervaz Profili
Architrave Profile
A-1010

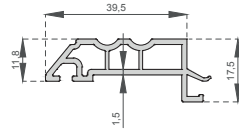

Motifli Pervaz Profili
Patterned Architrave Profile
A-1011

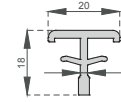

İnce Bağ Profili
Thin Bond Profile
A-1012

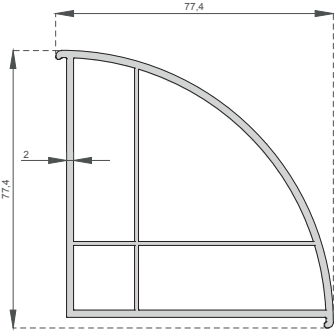

90 Derece Köşe Dönüş Adaptörü
90 Degree Corner Turn Adapter
A-1013

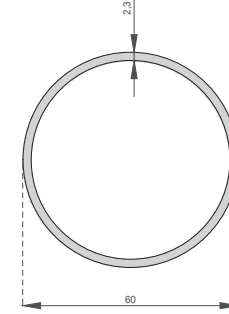

60'lık Boru Profili
60' Pipe Profile
A-1014

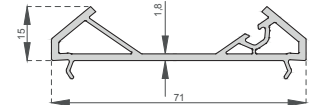

70'lik Köşe Dönüş Adaptörü
Corner Turn Adapter
A-1015

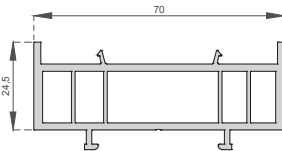

70'lik Kasa Yükseltme Profili
Frame Lifting Profile
A-1017

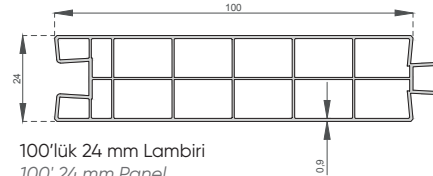

100'lik 24 mm Lambiri
100' 24 mm Panel
A-1019

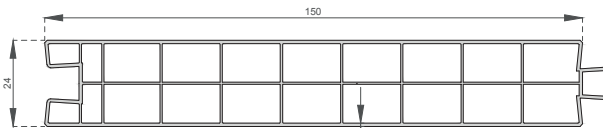

150'lik 24 mm Lambiri
150' 24 mm Panel
A-1020



Kasa Sol Conta
Frame Left Gasket
PSC 36



Kasa Sağ Conta
Frame Right Gasket
PSC 37



Kanat Üst Conta
Sash Upper Gasket
PSC 38

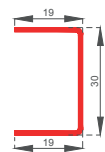

Pervazlı Kasa Destek Sacı
Reinforcement Steel For Frame With Architrave

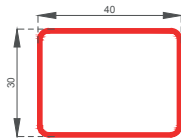

Kapı Destek Sacı
Reinforcement Steel For Door

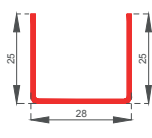

Kasa Destek Sacı
Orta Kayıt Destek Sacı
Kanat Destek Sacı
Hareketli Orta Kayıt Destek Sacı
Frame/Mullion/Sash/
Movable Mullion
Reinforcement Steel

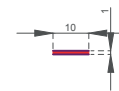

Pervazlı Kasa & Kanat Menteşe Destek Sacı
Hinge Support Reinforcement for Case and Sash with Architrave
A-1022

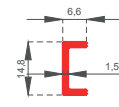

Menteşe Destek Sacı
Hinge Support Reinforcement for Case
A-1021

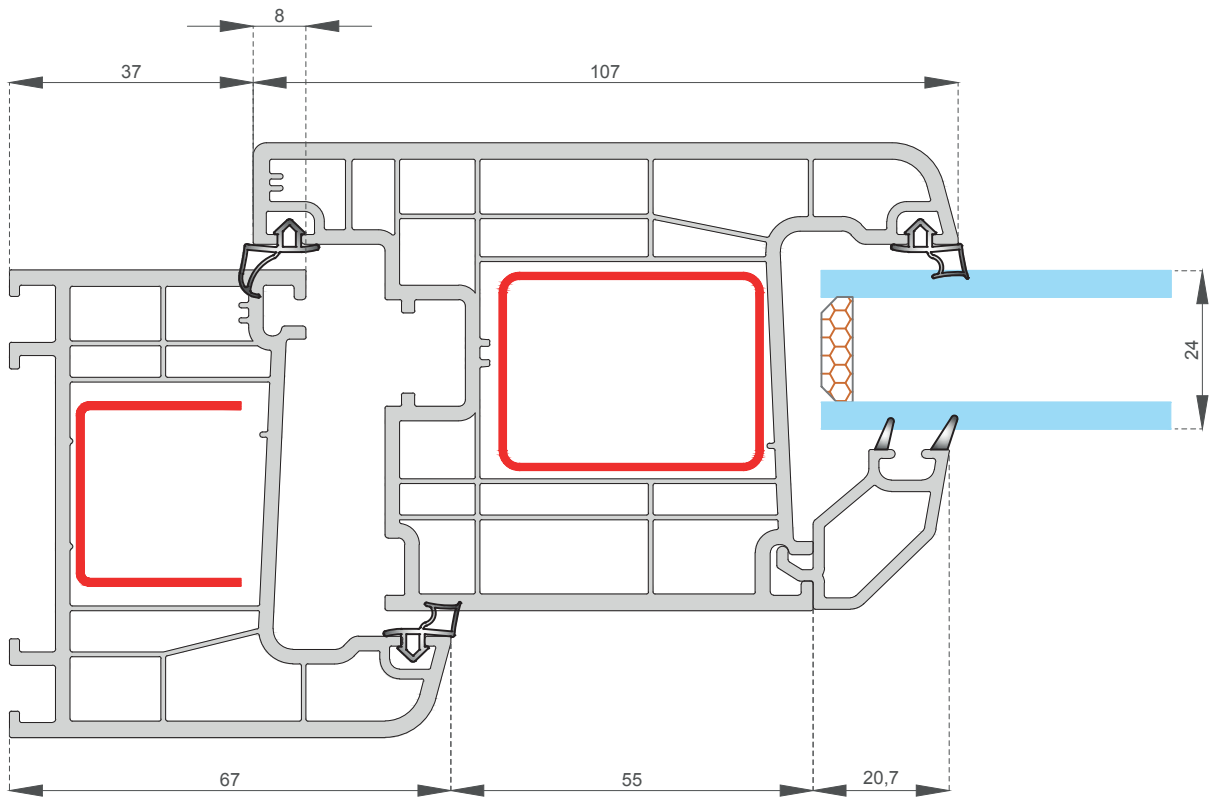
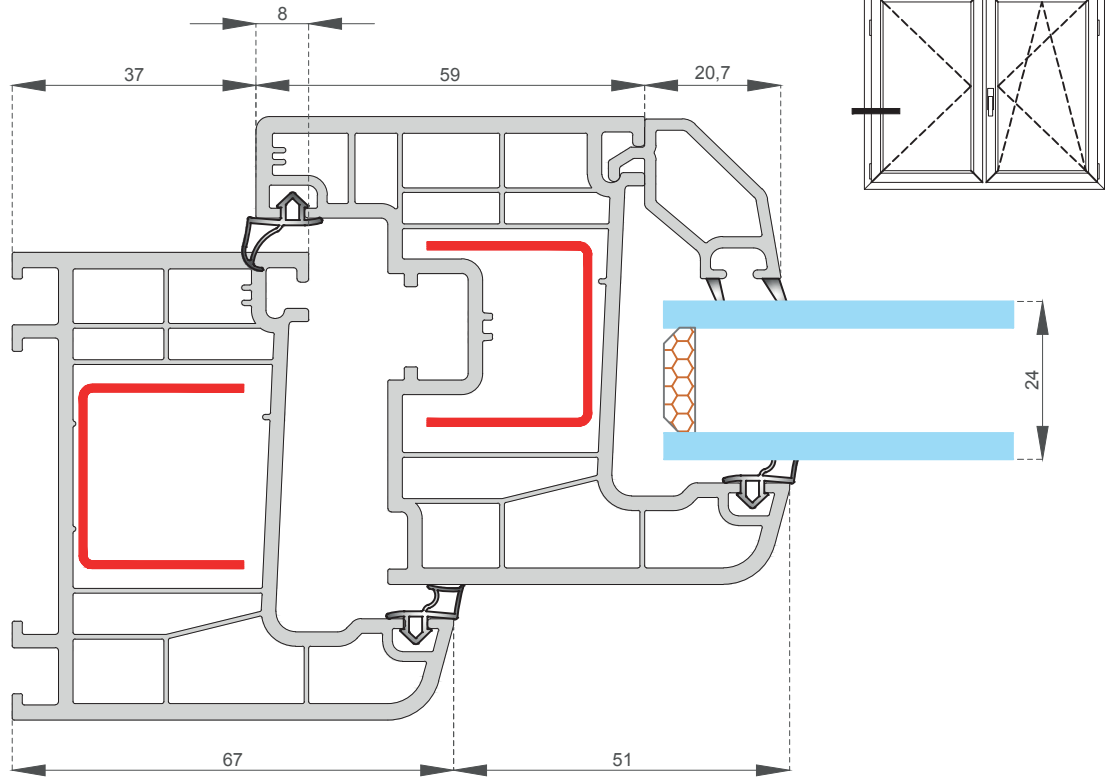

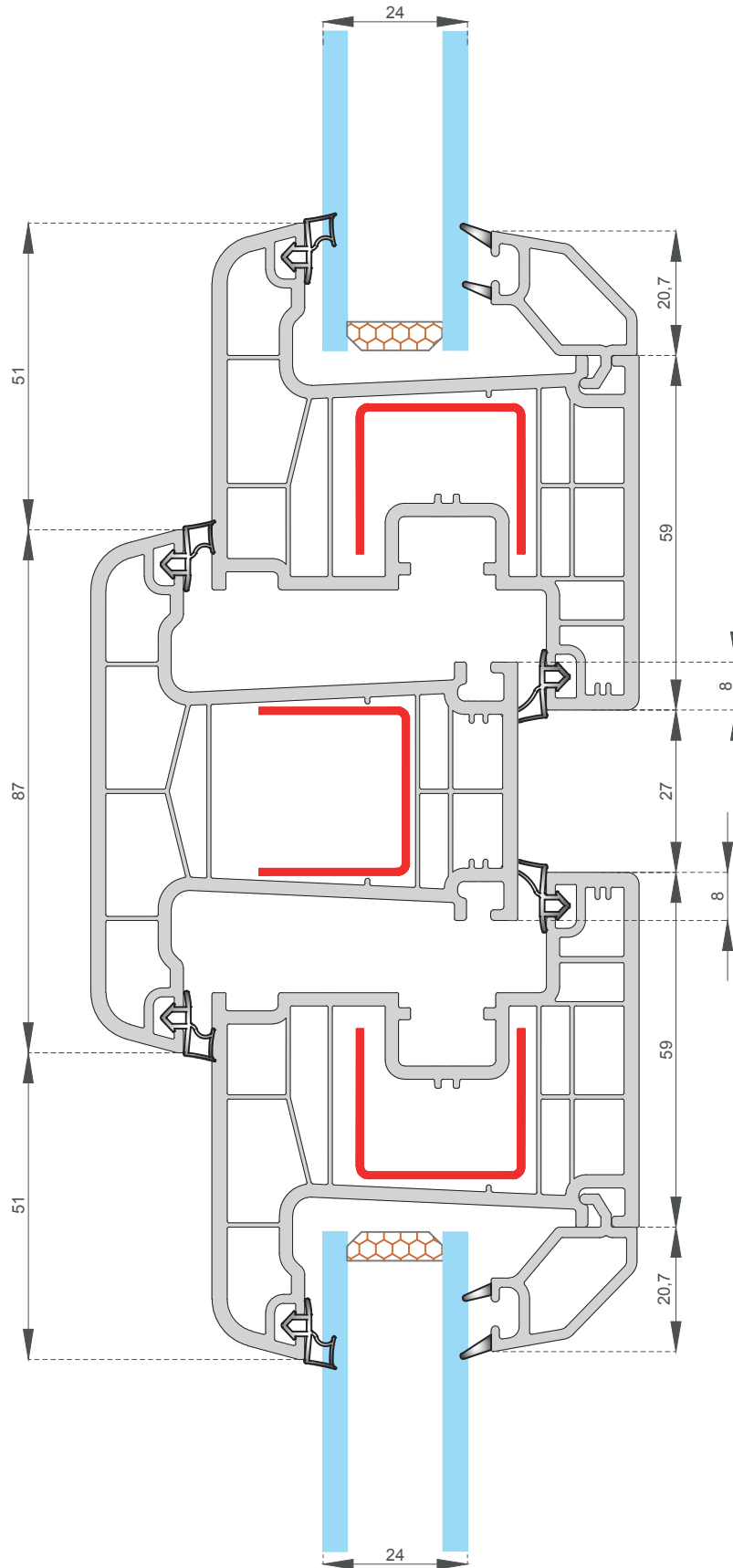

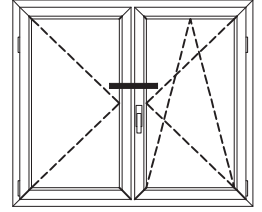
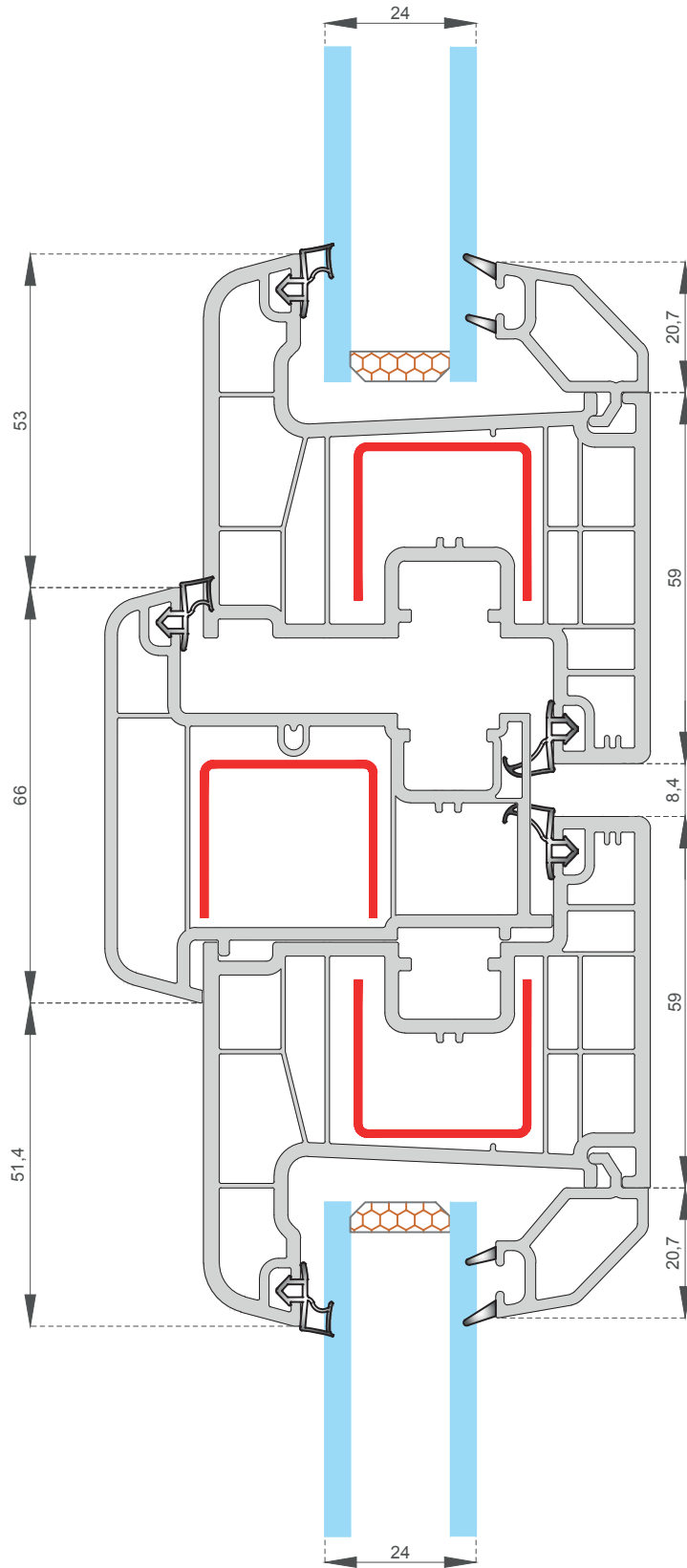



Teknik Detaylar / *Technical Details*

Profil Geniřliđi	<i>Profile Width</i>	60 mm	60 mm
Odacık Sayısı	<i>Number of Chambers</i>	4 Odacıklı Sistem	4 Chambers System
Conta Tipi / Rengi	<i>Gasket Model /Color</i>	TPE Siyah/Gri	TPE Black / Grey
Cam Kalınlıkları	<i>Glass Thickness</i>	4, 20, 24 mm	4, 20, 24 mm
Isı İletim Katsayısı UF	<i>UF Value</i>	1,37 W/m ² K	1,37 W/m ² K

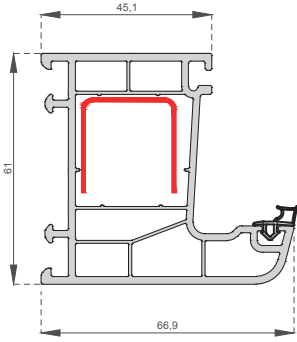

Kasa Profili
Frame Profile
C-6001

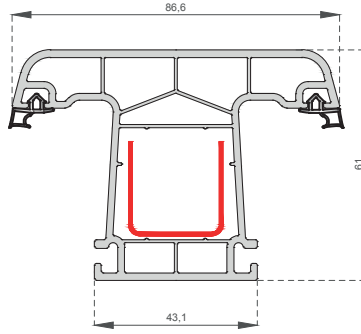

Orta Kayıt Profili
Mullion Profile
C-6002

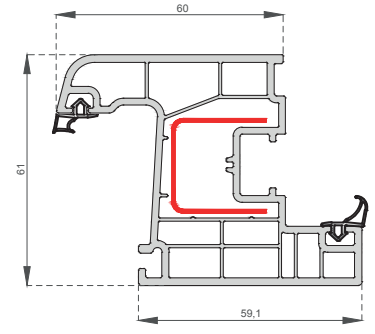

Kanat Profili
Sash Profile
C-6003

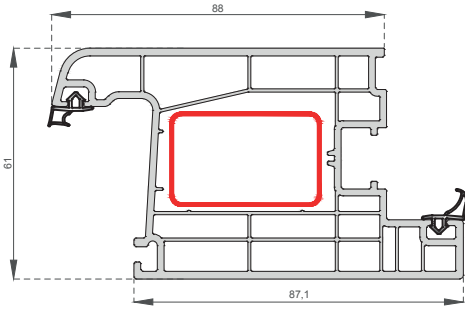

Kapı Profili
Door Profile
C-6004

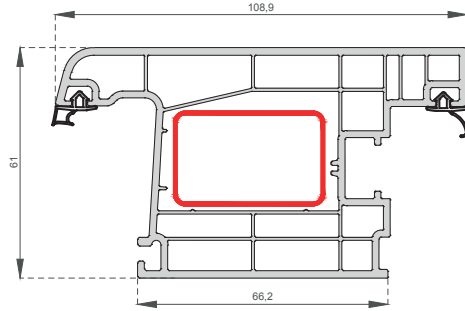

Dışa Açılır Kapı Profili
Outward Opening Door
C-6005

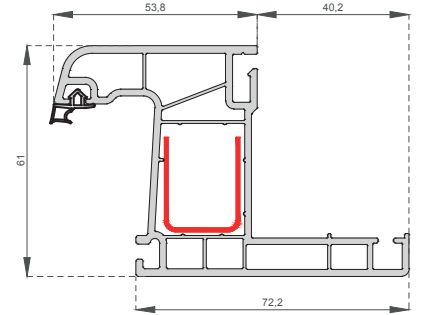

Pervazlı Kasa Profili
Frame Profile With Architrave
C-6006

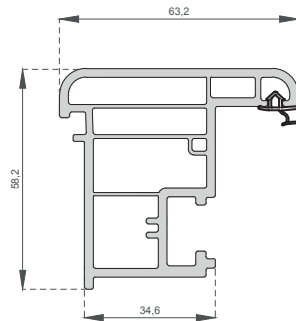

Hareketli Orta Kayıt Profili
Movable Mullion Profile
A-1009

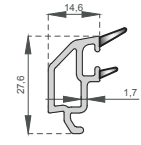

24mm.Cama Göre Çıta
Glazing With 24mm.Gap
A-1005

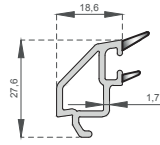

20mm.Cama Göre Çıta
Glazing With 20mm.Gap
A-1006

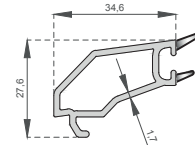

4mm.Cama Göre Çıta
Glazing With 4mm.Gap
A-1007

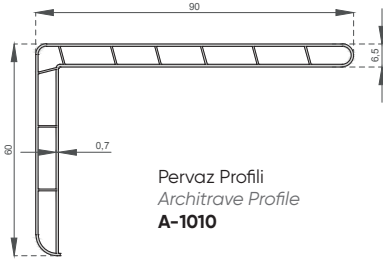

Pervaz Profili
Architrave Profile
A-1010

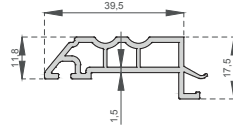

Motifli Pervaz Profili
Patterned Architrave Profile
A-1011

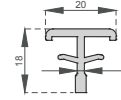

İnce Bağ Profili
Thin Bond Profile
A-1012

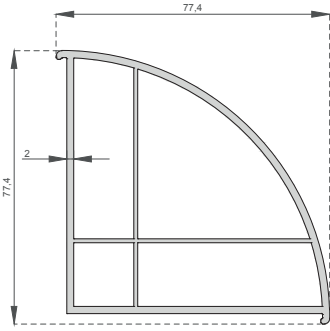

90 Derece Köşe Dönüş Adaptörü
90 Degree Corner Turn Adapter
A-1013

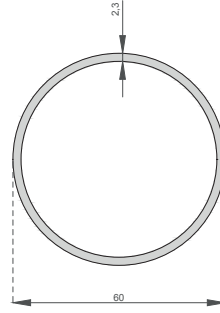

60'lık Boru Profili
60' Pipe Profile
A-1014

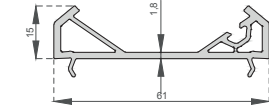

60'lık Köşe Dönüş Adaptörü
Corner Turn Adapter
A-1016

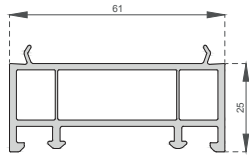

60'lık Kasa Yükseltme Profili
Frame Lifting Profile
A-1018

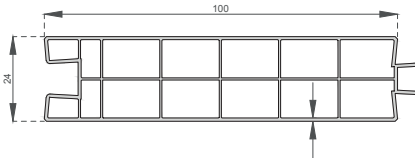

100'lük 24 mm Lambiri
100' 24 mm Panel
A-1019

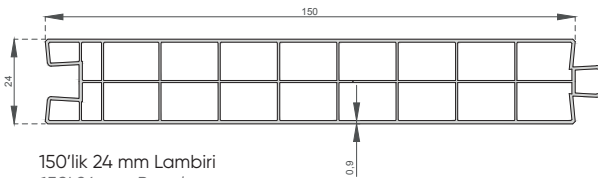

150'lük 24 mm Lambiri
150' 24 mm Panel
A-1020



Kasa Sol Conta
Frame Left Gasket
PSC 36



Kasa Sağ Conta
Frame Right Gasket
PSC 37



Kanat Üst Conta
Sash Upper Gasket
PSC 38

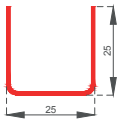

Kasa Destek Sacı
Orta Kayıt Destek Sacı
Kanat Destek Sacı
Frame/ Mullion /
Movable Mullion
Reinforcement Steel

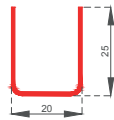

Pervazlı Kasa
Destek Sacı
Reinforcement
Steel For Frame
With Architrave

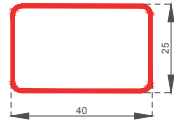

Kapı Destek Sacı
Reinforcement Steel
For Door

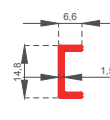

Mentşe Destek Sacı
Hinge Support Reinforcement
for Case
A-1021

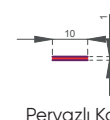

Pervazlı Kasa & Kanat
Mentşe Destek Sacı
Hinge Support Reinforcement
for Sash and Frame with Architrave
A-1022

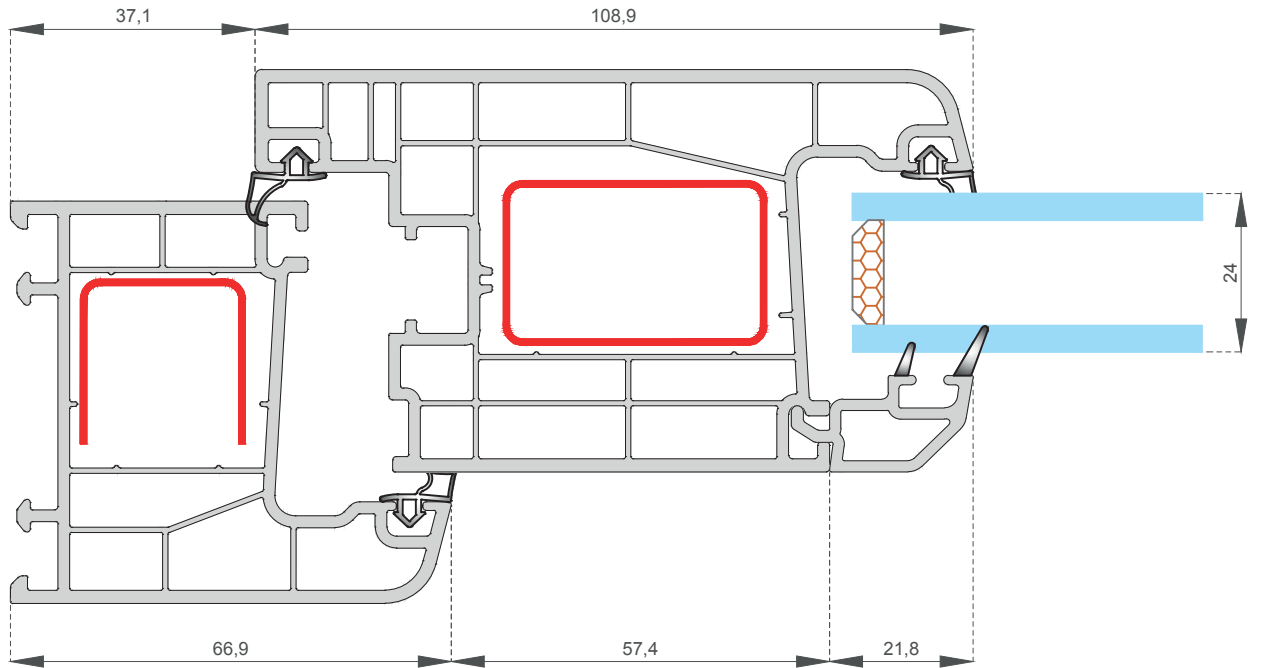
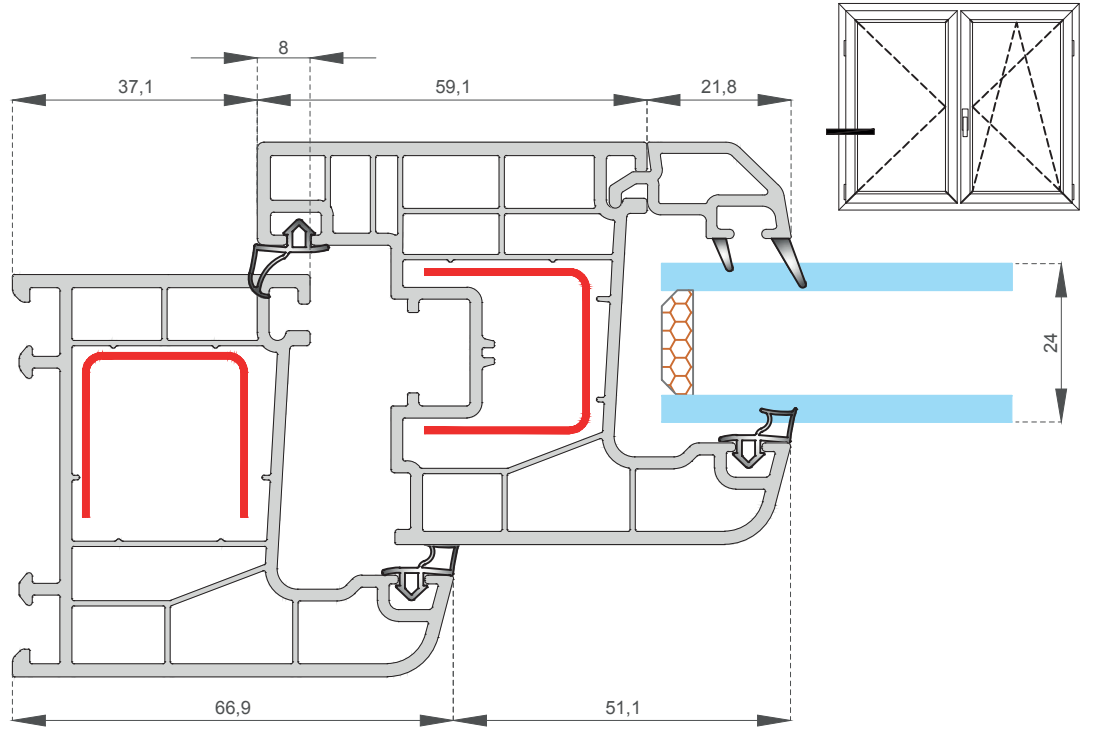

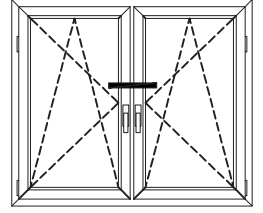
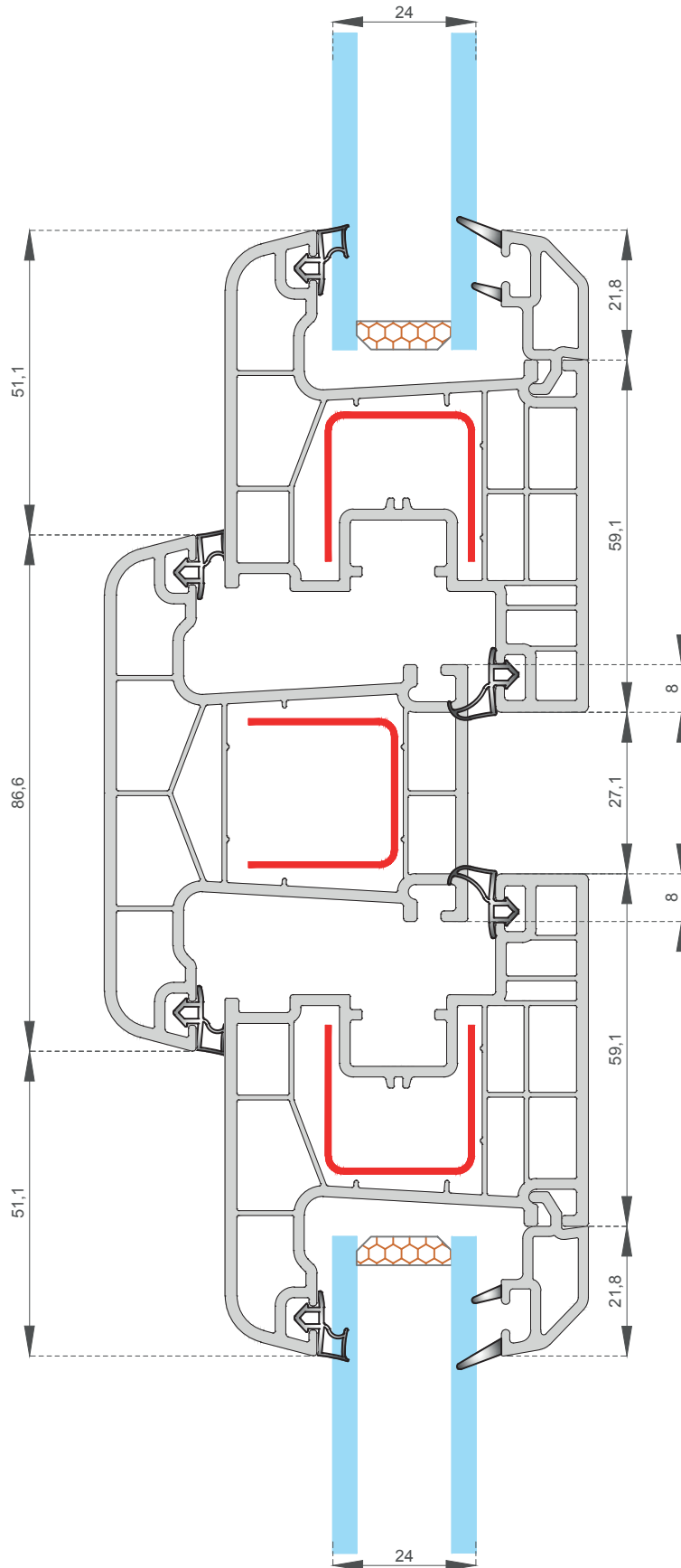

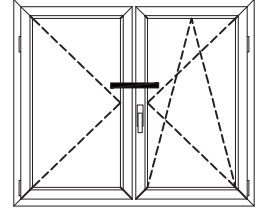
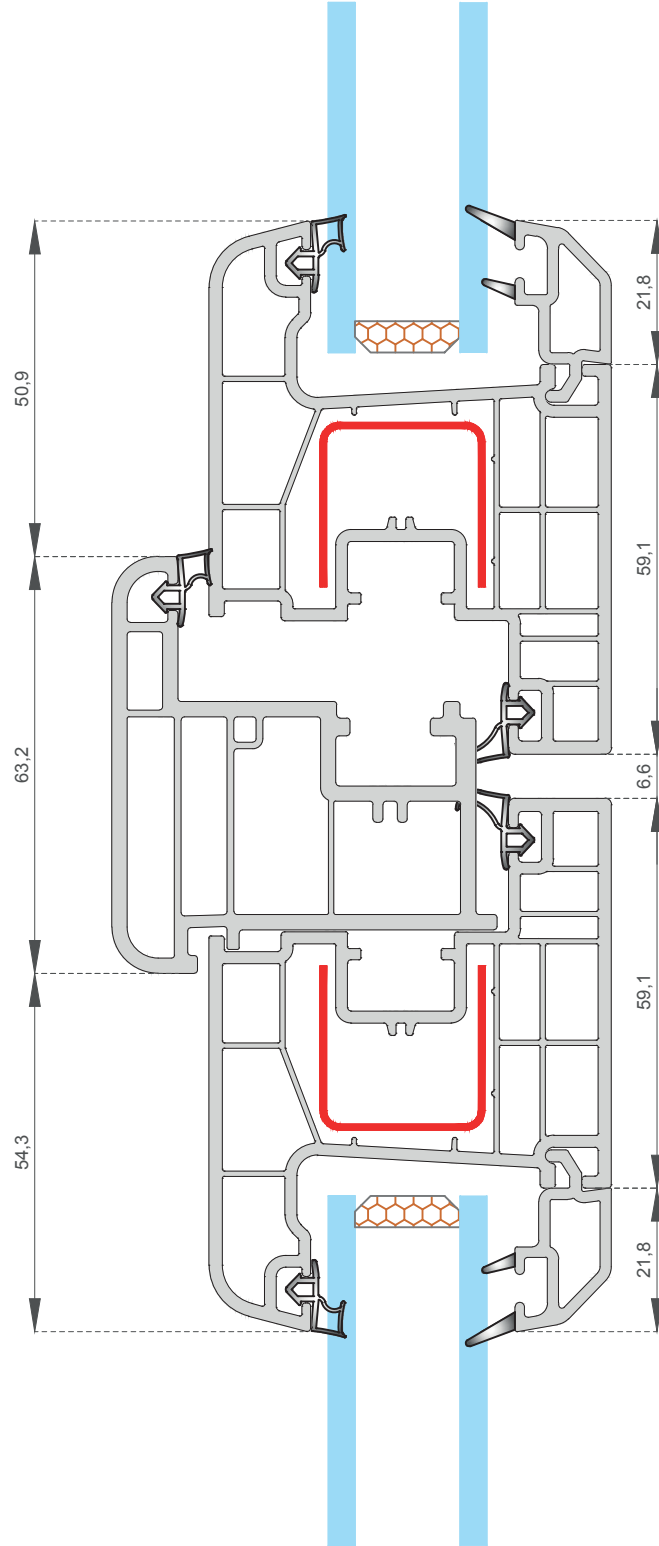

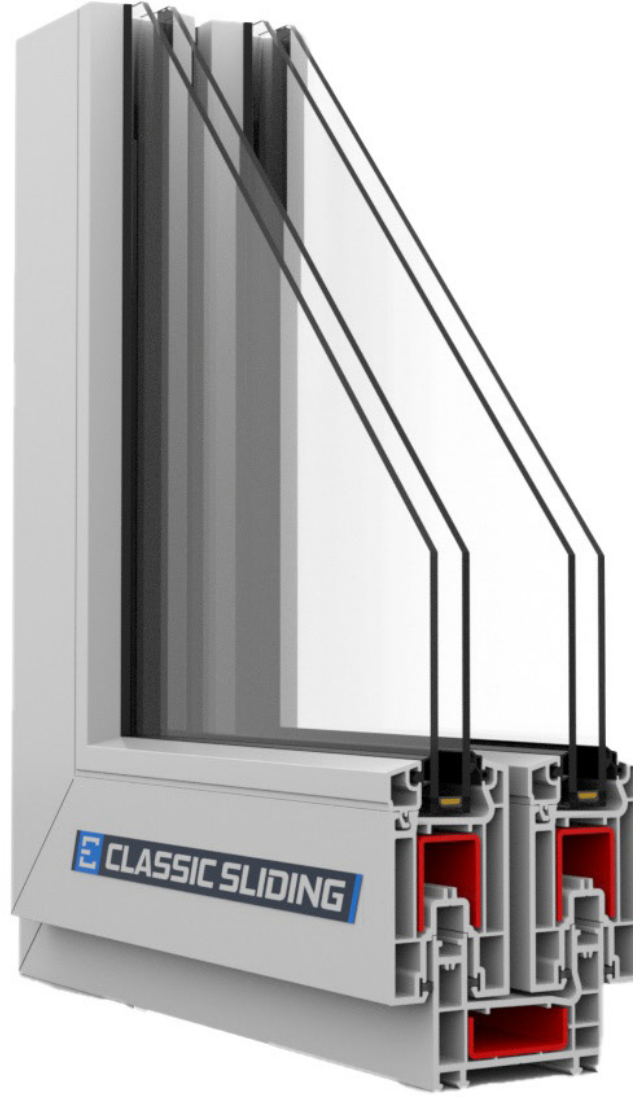

Teknik Detaylar / Technical Details

Profil Geniřliđi	Profile Width	78 mm	78 mm
Odacık Sayısı	Number of Chambers	3 Odacıklı Sistem	3 Chambers System
Conta Tipi / Rengi	Gasket Model /Color	TPE Siyah/Gri	TPE Black / Grey
Cam Kalınlıkları	Glass Thickness	4, 20 mm	4, 20 mm
Isı İletim Katsayısı UF	UF Value	1,95 W/m ² K	1,95 W/m ² K

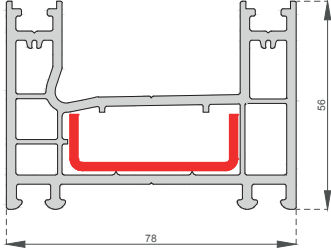

Kasa Profili
Frame Profile
CS-1001

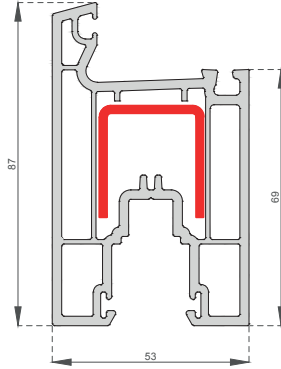

Kanat Profili
Sash Profile
CS-1002

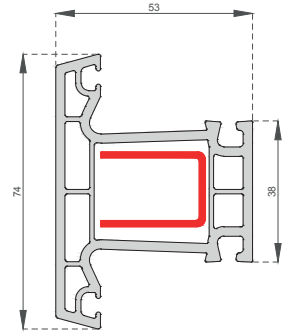

Orta Kayıt Profili
Mullion Profile
CS-1003

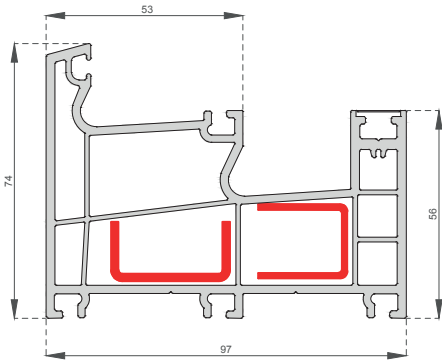

Dış Fix Kasa Profili
Outside Fix Frame Profile
CS-1004

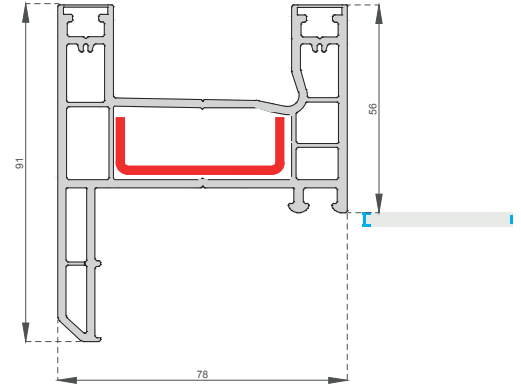

Pervazlı Kasa Profili
Frame Profile With Architrave
CS-1005

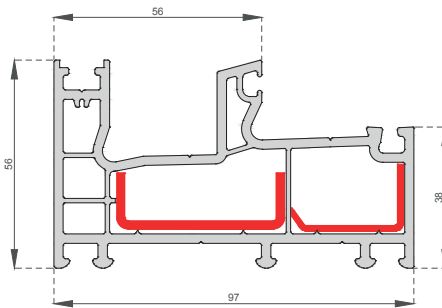

Fix Kasa Profili
Fix Frame Profile
CS-1006

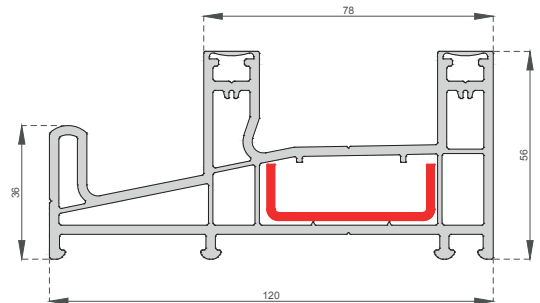

Sineklikli Kasa Profili
Frame Profile With Flyscreen
CS-1007

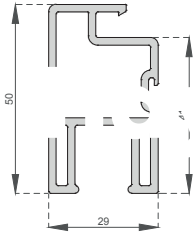

Sineklikli Kanat Profili
Flyscreen Sash Profile
CS-1008

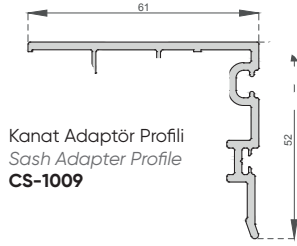

Kanat Adaptör Profili
Sash Adapter Profile
CS-1009

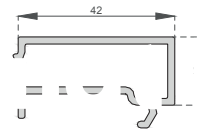

Kasa İnsert
Frame Insert
CS-1010

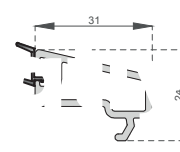

4 - 5 - 6 mm
Cam Göre Çita
Glazing Bead for
4-5-6 mm Glass
CS-1011

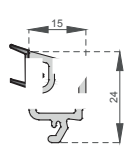

20 mm
Cam Göre Çita
Glazing Bead for
20 mm Glass
CS-1012

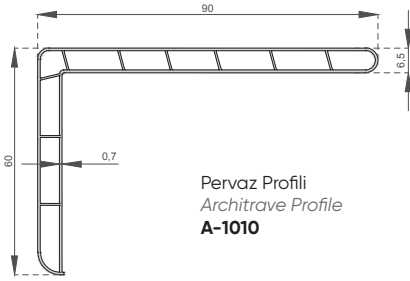

Pervaz Profili
Architrave Profile
A-1010

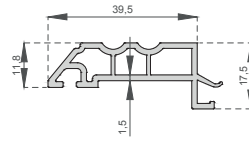

Motifli Pervaz Profili
Patterned Architrave Profile
A-1011

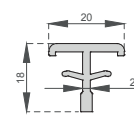

İnce Bağ Profili
Thin Bond Profile
A-1012

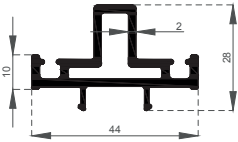

Alın Alına Kanat Kapama
Alüminyum Profili
Sash Lock Adapter Profile
ER 7254
0,743 Kg/m

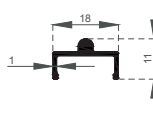

Dıştan Geçme Alüminyum
Sürme Ray
External Fitting Aluminium
Sliding Rail
ER 7265
0,114 Kg/m

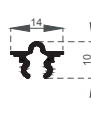

Alüminyum Ray
Yeni Sürme Profili
Aluminium Rail
New Sliding Profile
ER 7266
0,089 Kg/m

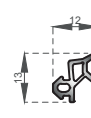

Kanat Contası
Sash Gasket
PSC 39

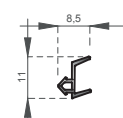

Çita Contası
Glazing Bead Gasket
PSC 40

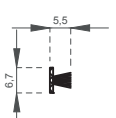

67x550 Kıl Fitol
Brush Gasket 67x550
PSC 41

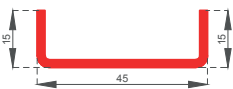

Kasa - Fix Kasa Profili Destek Sacı
Frame - Fixed Frame Profile
Reinforcement Steel

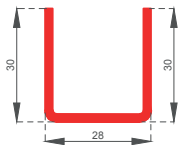

Kanat Profili Destek Sacı
Sash Profile Reinforcement Steel

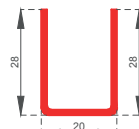

Orta Kayıt Profili Destek Sacı
Mullion Profile Reinforcement Steel

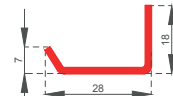

Fix Kasa Profili Destek Sacı
Fixed Frame Profile
Reinforcement Steel

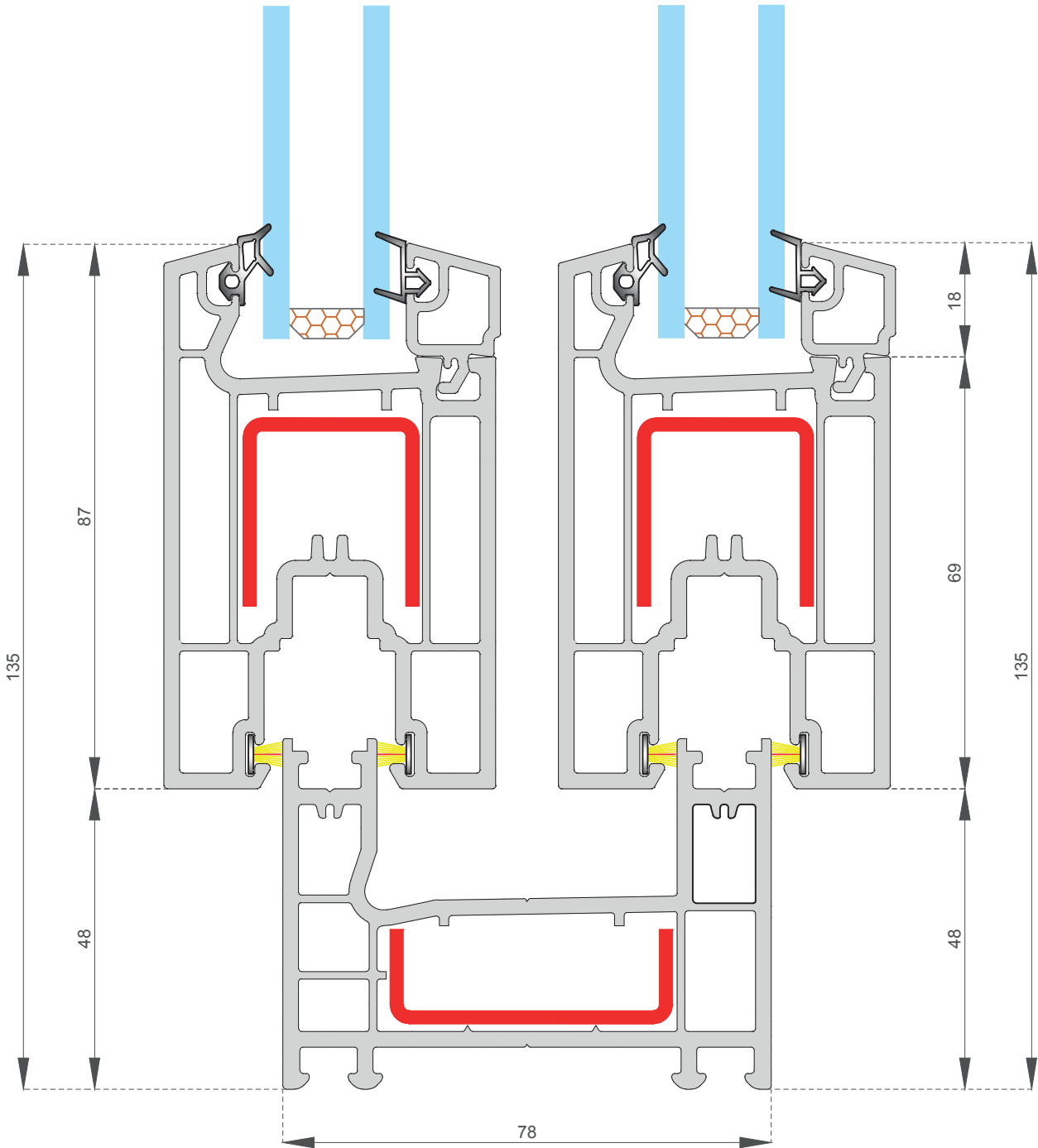
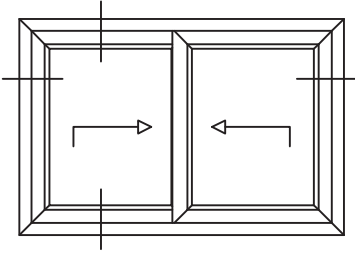

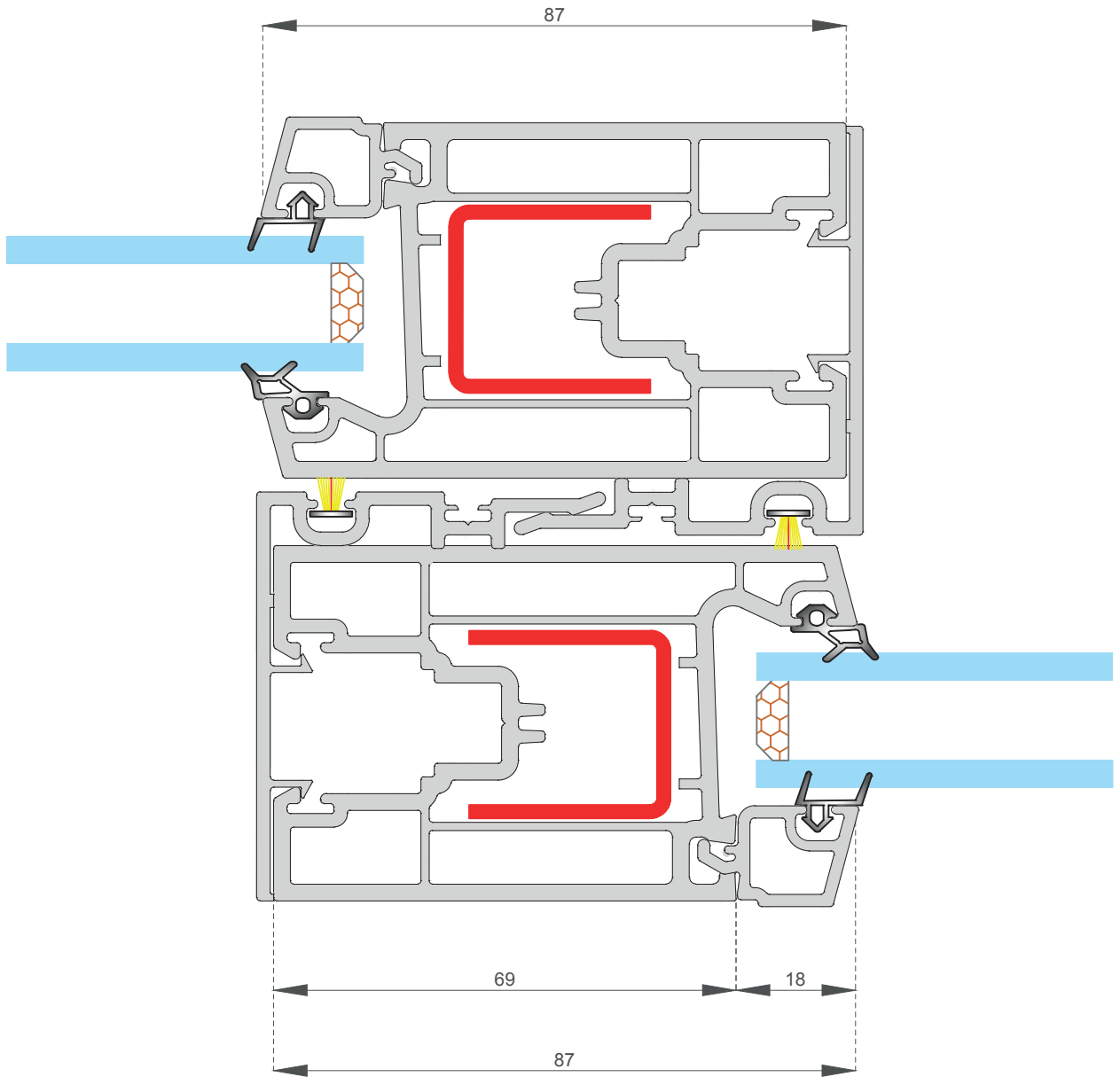
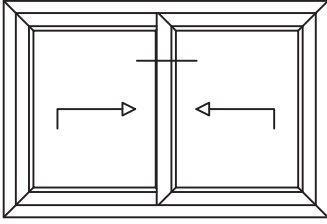

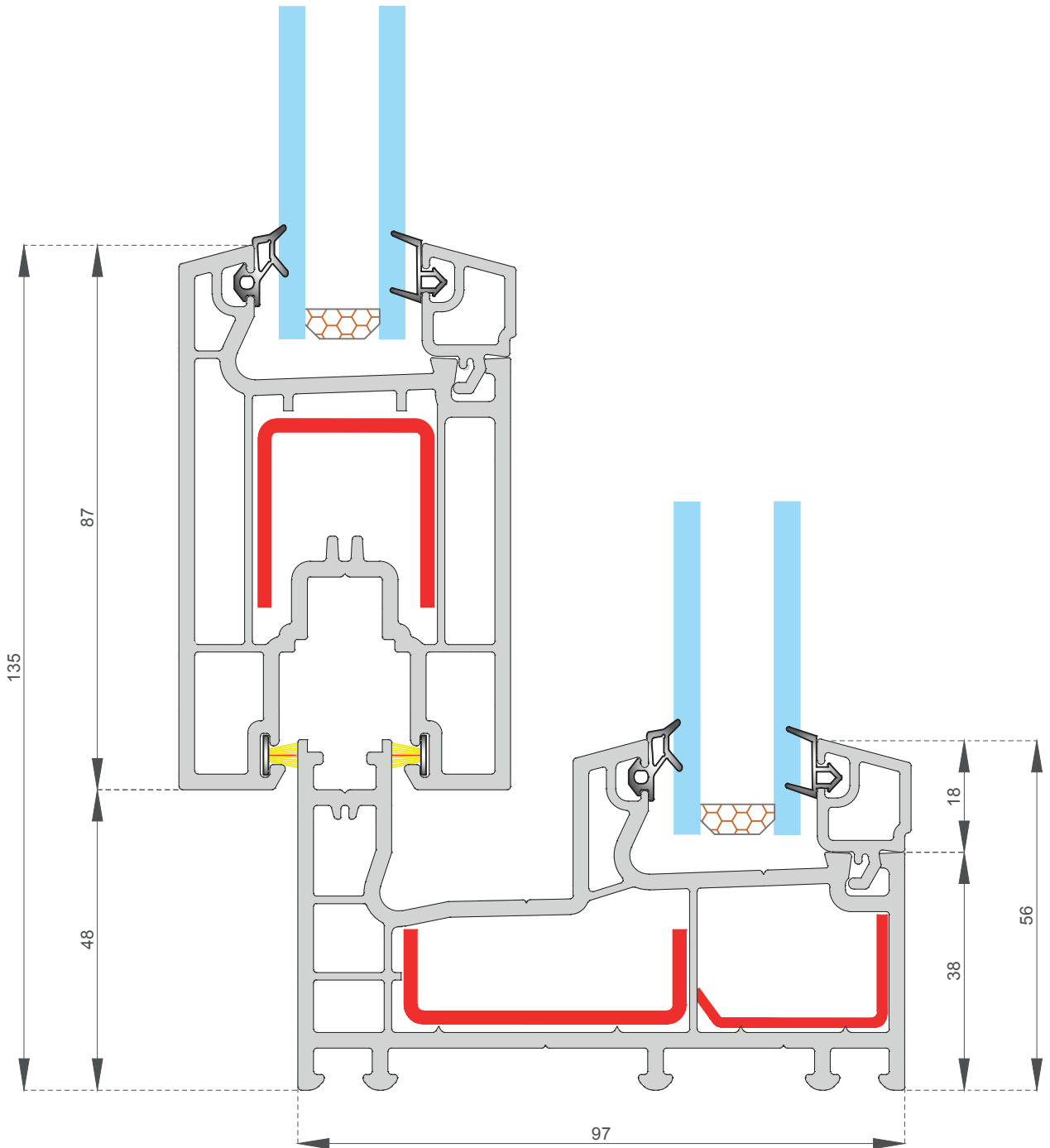
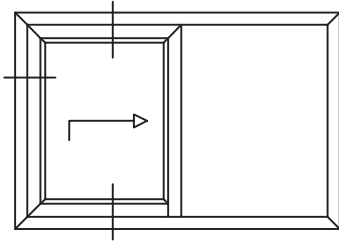

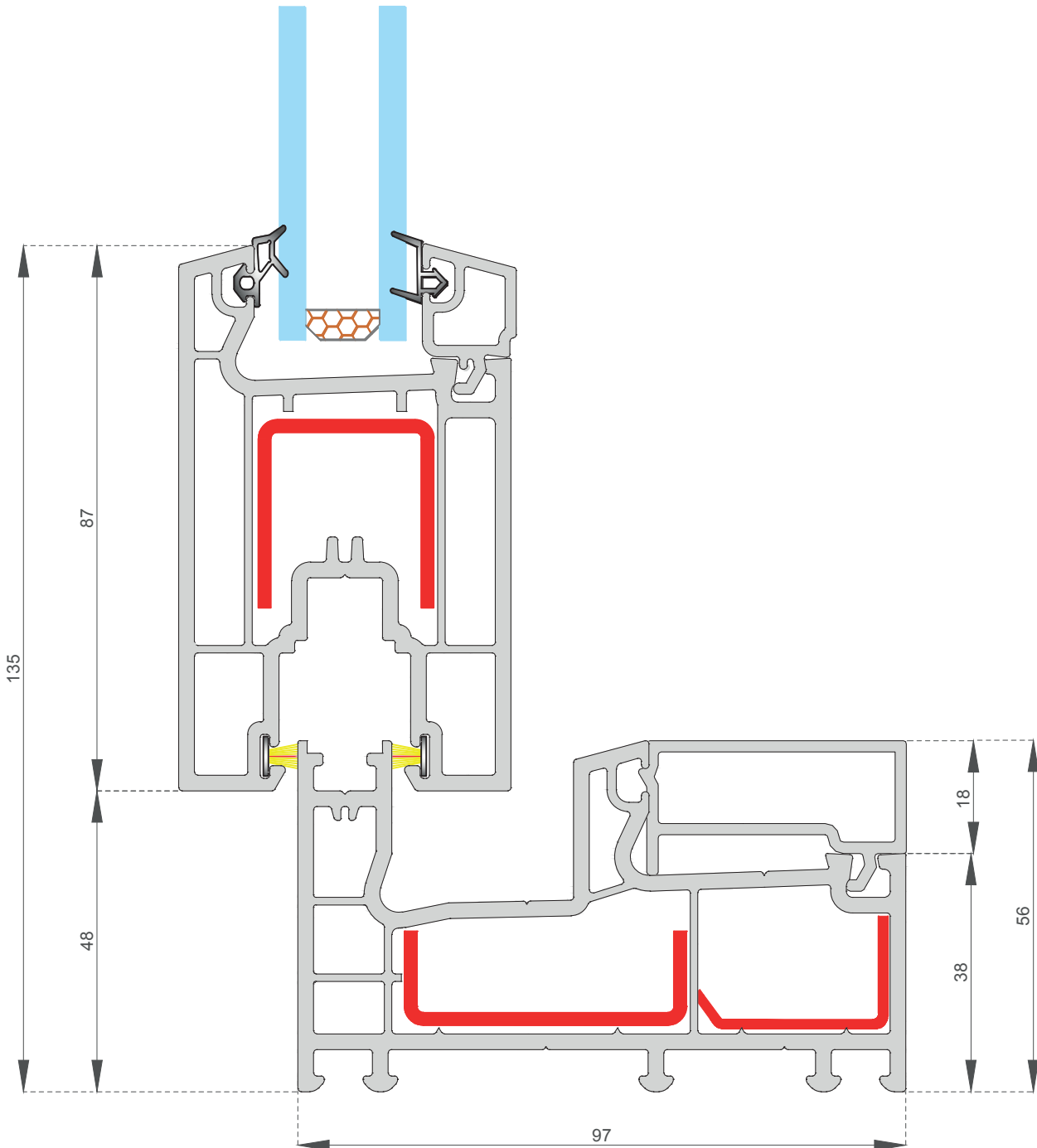
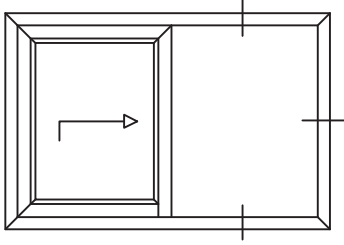



Zengin Renk Seçenekleri ile

With Rich Color Options



Beyaz / *White*



Gri / *Gray*

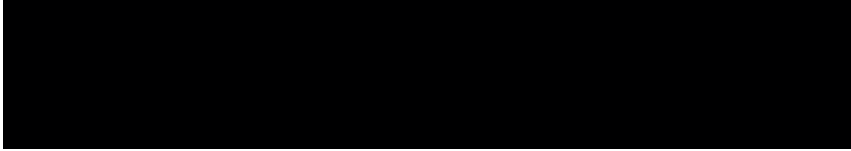

Siyah / *Black*



Antrasit / *Hard Coal*



Altın Meşe / *Golden Oak*



Koyu Meşe 1 / *Dark Oak 1*



Koyu Meşe 2/ *Dark Oak 2*



Olgun Kiraz / *Burgundy Cherry*

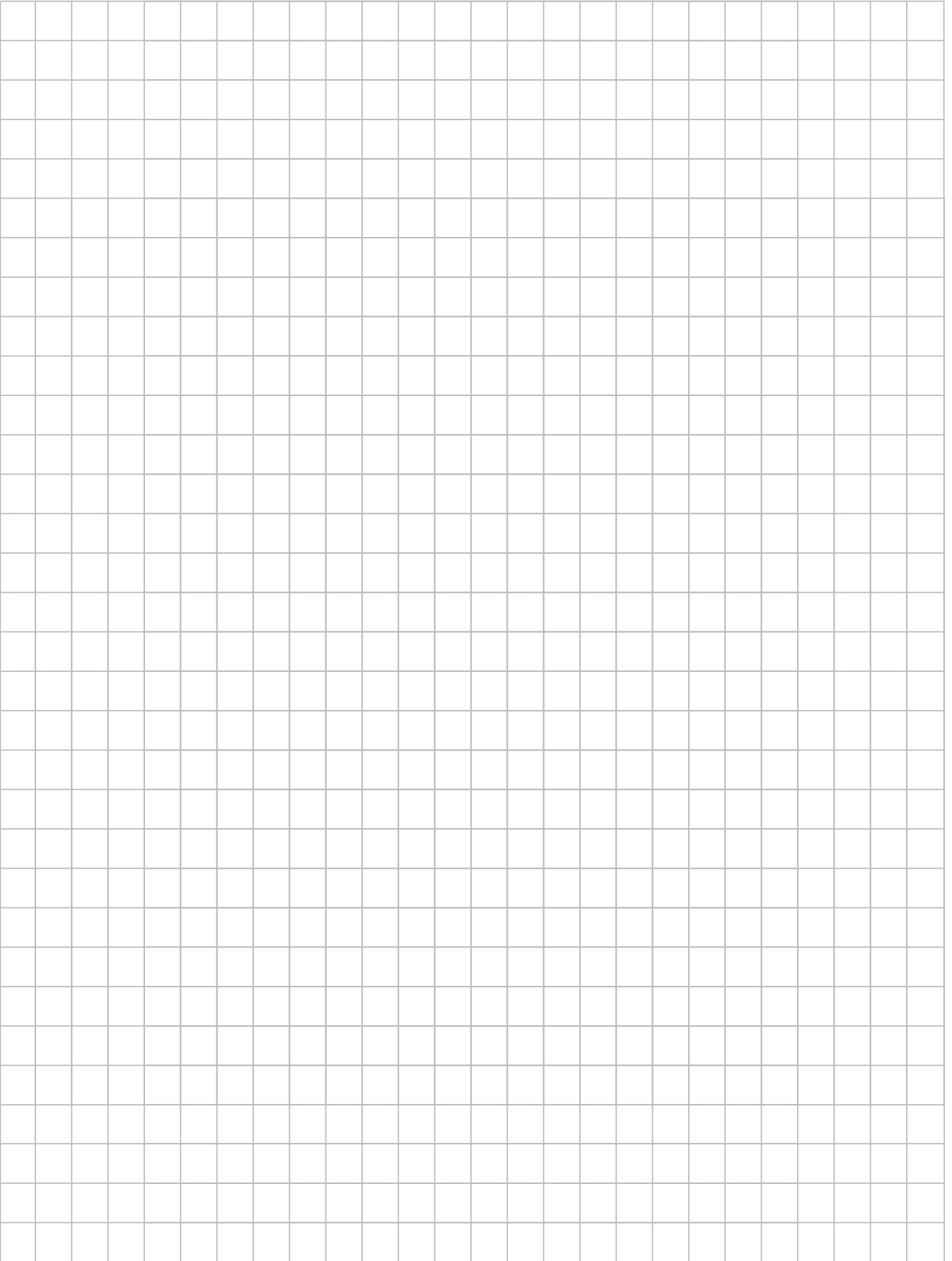



 **ERSAŞPEN®**

Hayatınıza Sanat Katıyoruz

We Add Art to Your Life

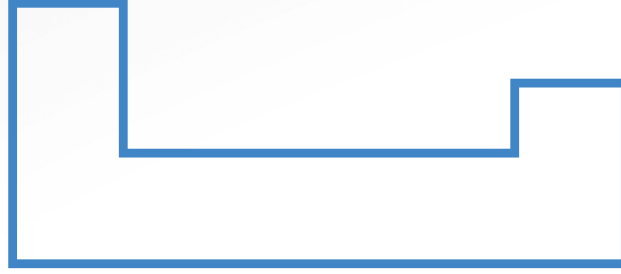
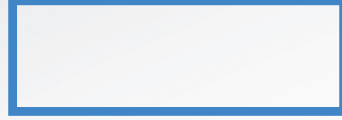

 **ERSAŞPEN**[®]



Genel Müdürlük

İncirlik Sk. No: 11-15, PK 34050,
Eyüpsultan/İstanbul/Türkiye

Tel: +90 (212) 674 12 14

Fax: +90 (212) 674 12 17

E-Mail: ersaspen@ersaspen.com.tr



Fabrika

Ergene 1 O.S.B Vakıflar O.S.B Mh.
Sanayi Cd. No: 19-1
Ergene/Tekirdağ/Türkiye

Tel: +90 (282) 683 20 22

Fax: +90 (282) 683 20 28